

## MCP SmartFilter, MCP SmartFilter Ex

Compact cartridge filter for solving dust problems within a wide range of industries



MCP-8-32S with 13 gal. dust bin



MCP-8-32S-Ex with 13 gal. dust bin

### Description

MCP SmartFilter is multi-purpose cartridge filtration system for both indoor and outdoor installations. It can be used for many different applications. It has a compact design with a low height and a small footprint. Constructed in 14 GA galvanized steel panels, it is easy to install, cost effective to ship and provides corrosion protection.

The filtration system has a new and innovative cartridge design. The squircle shape utilizes the square space within the dust collector in the most optimal way and generates high cartridge airflow. Thus, decreasing the size and hence the footprint of the system.

Insight ready control with advanced pulse cleaning logic provides for full system operation including control and monitoring, as well as gateway functionality for cloud communication.

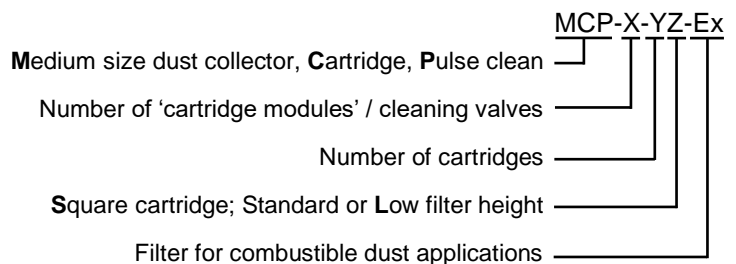

### Specification

- 14 GA galvanized steel
- Bolted and clinched assembly
- Indoor and Outdoor placement
- Pulse jet cleaning (on-line) with high efficiency diaphragm valves for stronger cleaning power
  - 2 SCF per cleaning pulse at 90 psi compressed air\*
- Different cartridge media types available
- Light weight bolt on access door
- Internal strike plate with perforated distribution sheet to evenly distribute dust load

### Product Marking of MCP SmartFilter Ex

CE II 1D/3D/- c Ex h IIIC 248°F Da/Dc/-

\*for some applications it is possible to go up to 100 psi compressed air

## Options

- Hinged door versions for easier maintenance
- Sheet against abrasive dust (air flow protection for filter elements)
- Silotop-flanged solutions
- BIG (single outlet) hopper versions (for 6 and 8 module filters)
- Clean air chamber with larger heights for higher air flow: 13.80 inches, 19.70 inches and 25.60 inches
- Cold environment solutions (up to -40°F)\*
- Clean Filter Exchange system (Bag In Bag Out)\*
- Secondary or exhaust filter\*
- Wet-painted filter in customized colours (RAL)\*

\*Not available as standard, available by request

Max. vacuum	Max. overpressure	Operation / Ambient temperature
24 In.wg.	0 In.wg. (6 In.wg.)*	-4°F to +158°F

\* Operation with overpressure only allowed with silotop versions.

- Insight Control Panel for monitoring and control, Insight Ready (connectivity module to connect to Nederman's cloud based filtration knowledge center, Insight Analytics).



Insight Control Panels

## Explosion protection options

- Collector equipped with ATEX certified explosion relief panels for combustible dust handling
  - Vertical and horizontal explosion venting possible with relief panels for outdoor placement
  - Flameless venting or chemical suppression/HRD (high rate discharge) possible by request

Pred,max	KST	Zone Placement
0,3 bar	St1 (0 to 200 bar FPM) St2 (> 200 to 300 bar FPM) St3 (> 300 bar FPM)*	None-zone Zone 22*

\*Not available as standard, available by request

## Cartridge material

- SC100 – Spunbond polyester
- SC140 – Spunbond polyester with antistatic treatment
- SC141 – Spunbond polyester with antistatic treatment and PTFE coating
- SC150 – Spunbond polyester with ePTFE membrane
- SC151 – Spunbond polyester with antistatic treatment and ePTFE membrane
- SC190 – Spunbond polyester with PTFE coating

## Requirements

- Compressed air requirements: ½" pipe thread at air tank, 90 to 100 psi dry and oil free (acc. ISO 8573-1: class 3 for area exposed to risk of frost, class 4 frost-proof building / area). Supply pipe should be 1" or larger.
- Electrical requirements\* for Insight Control Panel:

Standard panel 1x120 VAC/60 Hz, Premium EX panel 3x230/480/575 VAC/60 Hz

MCP-2-8S / MCP-2-8S-Ex  
MCP-2-8SL / MCP-2-8SL-Ex

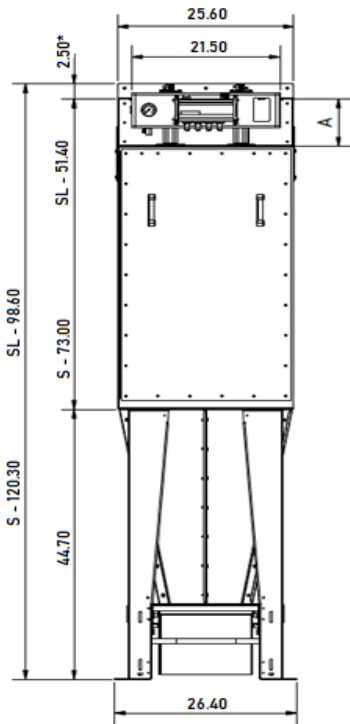

MCP-4-16S / MCP-4-16S-Ex  
MCP-4-16SL / MCP-4-16SL-Ex

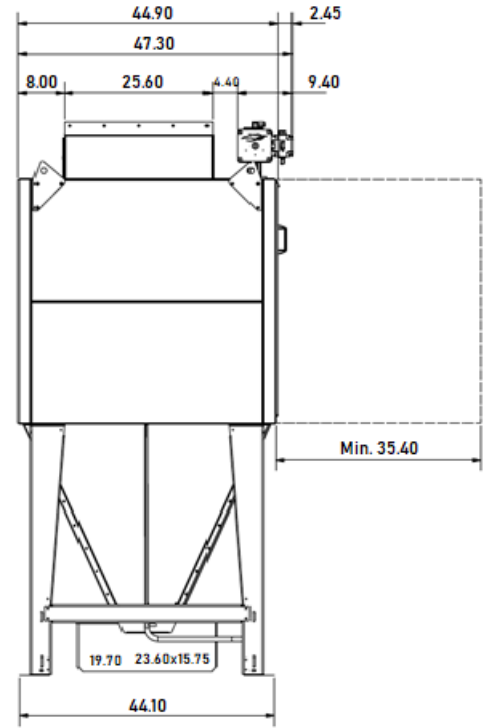
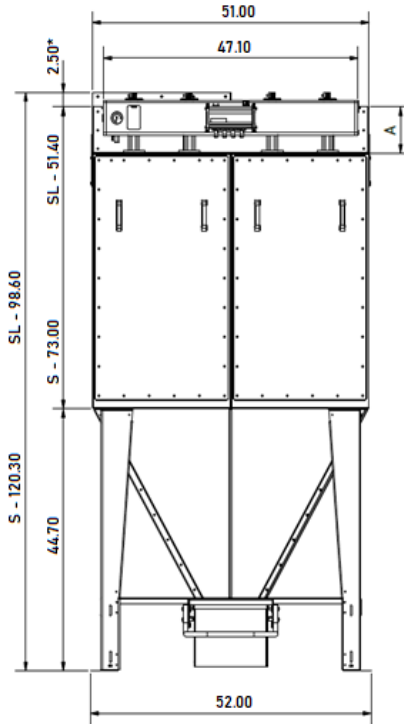

MCP-6-24S / MCP-6-24S-Ex  
MCP-6-24SL / MCP-6-24SL-Ex

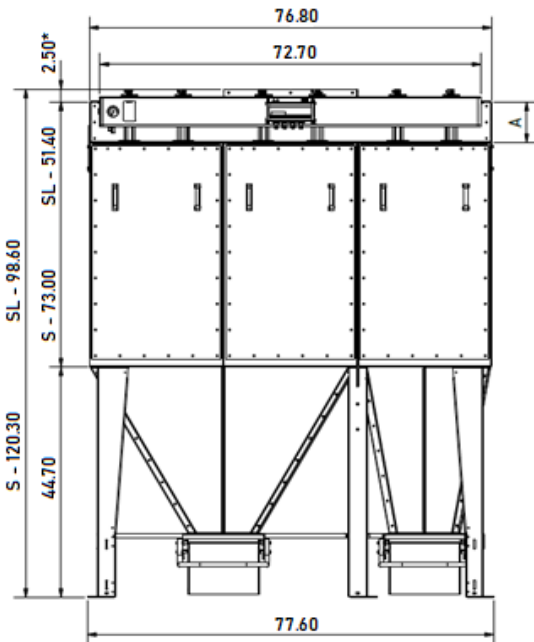

MCP-8-32S / MCP-8-32S-Ex  
MCP-8-32SL / MCP-8-32SL-Ex

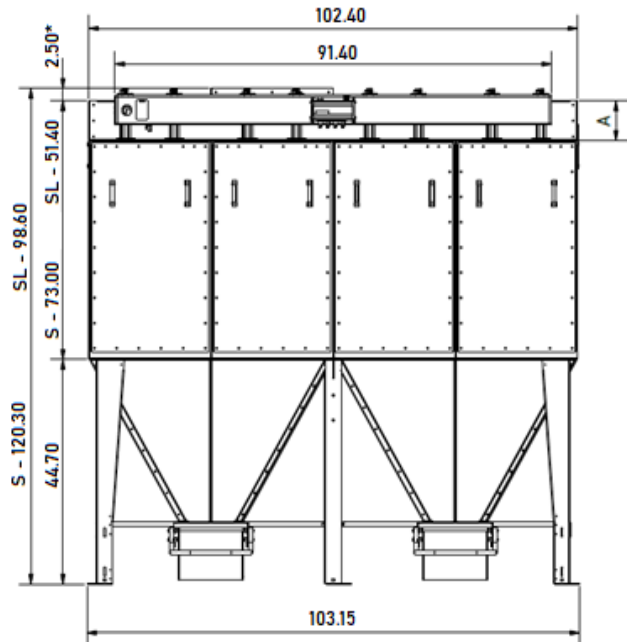

All dimensions in inches.  
Dimensioned with 13 gallons dust bin without wheels.  
For 13 gallons dust bin with wheels, add 3.50 inches.  
\* to be included only if a top mounted FM fan is used (transition for fan).

A – Height of Clean Air Chamber [in]			
7.90	13.80	19.70	25.60
Shown in drawings	Add 5.90 inches in height	Add 11.80 inches in height	Add 17.70 inches in height

## Filter area

Filter type	Quantity of cartridges	Filter area [ft <sup>2</sup> ]		Max. airflow [CFM]*
		SC100, SC140, SC141, SC150, SC151, SC190	SC178	
MCP-2-8S MCP-2-8S-Ex	8	517	1137	4120
MCP-4-16S MCP-4-16S-Ex	16	1033	2273	8240
MCP-6-24S MCP-6-24S-Ex	24	1550	3410	12360
MCP-8-32S MCP-8-32S-Ex	32	2067	4547	16480
MCP-2-8SL MCP-2-8SL-Ex	8	327	723	2649
MCP-4-16SL MCP-4-16SL-Ex	16	654	1447	5297
MCP-6-24SL MCP-6-24SL-Ex	24	982	2170	7946
MCP-8-32SL MCP-8-32SL-Ex	32	1309	2893	10594

\*Max. air flow is dependent on the dust type, etc.

## Inlet options

Available inlet diameters: Ø 6, 10, 12, 16, 20 and 24 inches.

Depending on the filter size and air flow one or two standard filter inlets can be used.

Standard inlets are available as accessories with three different duct connection types: QuickFit (QF), Flange (FL) and Spiro (SP). Available inlet diameters for duct connection are Ø6, Ø9, Ø14, Ø16 and Ø20 inches.

Beside standard inlets, T-pieces for connection of two standard inlets Ø16 inches are available for Ø20 inches duct connection; as well as single and double backpacks with bigger inlet opening Ø24 inches.

For combustible dust single and double backpacks can be used to vent vertically if there is no sufficient space for venting area with horizontal venting.

**Example:** MCP-4-16SL configuration with FM-fan, standard inlet, fan outlet and 13 gal. dust bin

## Outlet options

Available Outlet diameters: Ø 6, 10, 12, 16, 22 or 24 inches.

There are different filter outlets possible, depending if an on-built FM-fan is used or a remote fan.







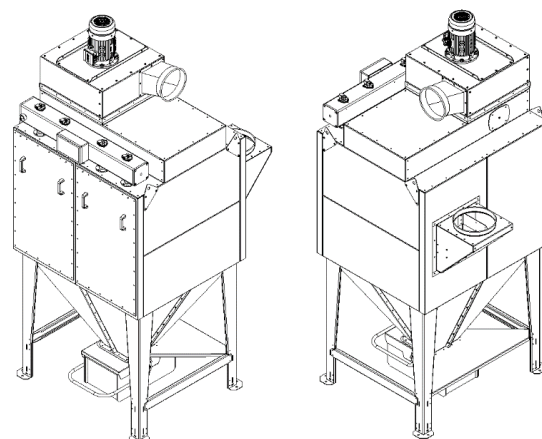

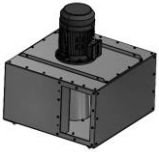
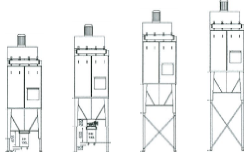
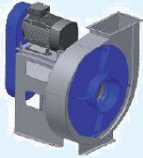
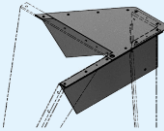

For an on-built fan, the filter has a rectangular transition on top of the clean air chamber for connection. Fan outlets in mentioned diameters are available for the different FM-fan sizes.

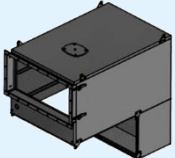
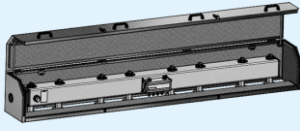
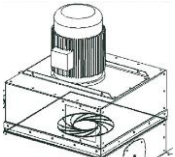
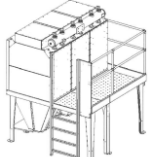
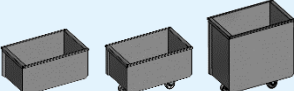
For a remote fan, the filter can have clean air chamber outlets either on the left or right side or on the top. These outlets are available in mentioned diameters, outlet to the top is only available in Ø20 inches.

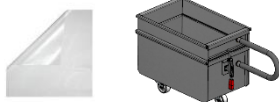
The clean air chamber can be configured for different heights depending on the air flow: 7.90 inches, 13.80 inches, 19.70 inches and 25.60 inches.

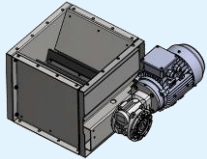

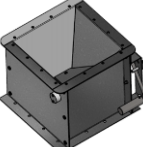
Accessories

Figure	Description	Figure	Description
	Top mounted FM-fans 50 Hz or 60 Hz up to 8240 CFM		Leg height extensions from 0 inch to 78.70 inches to fit larger bins/containers, rotary valves and big bags
	Combifab remote fans 50 Hz or 60 Hz		Leg width extension 11.80 inches to left, right or both sides to fit larger bins/containers, rotary valves and big bags
	Noise enclosure to reduce fan and motor break-out-noise of FM-fans		Suspension below rotary valve for big bag
	Dual silencer to reduce air flow, fan noise and motor break-out-noise of FM-fans (available with grid (indoor use), grid and rain cover (outdoor use) or flange for duct connection)		Isolation box for pressure tank incl. cleaning valves
	Regulation (iris) damper at fan inlet for FM-fans		Access platform with ladder for maintenance
	Dust bins (13 gal., 13gal. with wheels and 26 gal. with wheels)		Lime feeder NFKG-70
	Plastic bag in the dust bin with pressure compensation set 'bin balancing'		Several sensors available for extraction, filtration and discharge process
	Rotary valves NRS3 and NRSZ3		Water separator and pressure regulator
	Dust discharge valve NFUS3		QF- duct system